

1505

Waddling Duck

81 pieces

A custom model design by  
Jason Allemann

[jkbrickworks.com](http://jkbrickworks.com)

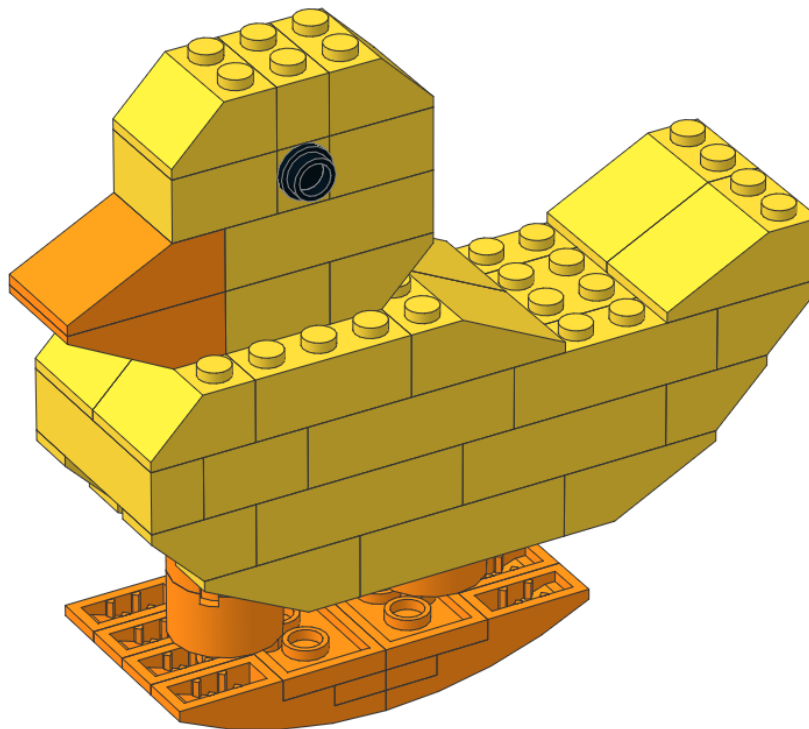

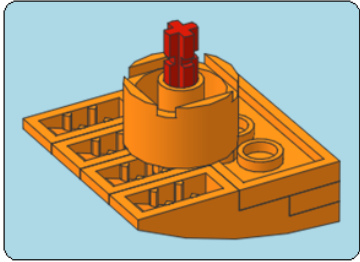

x2

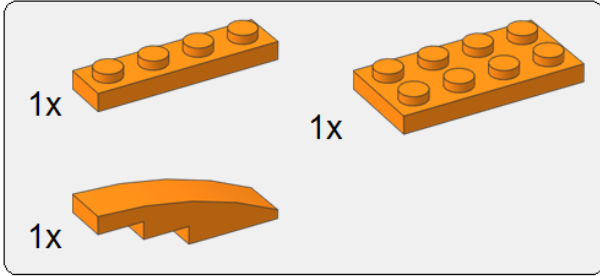

1

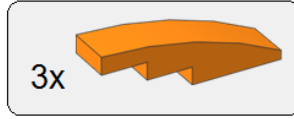
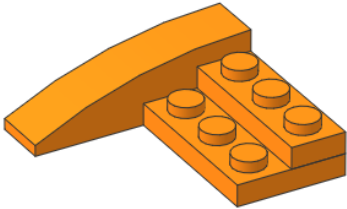

2

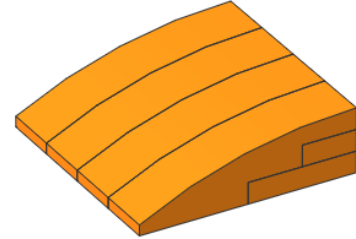

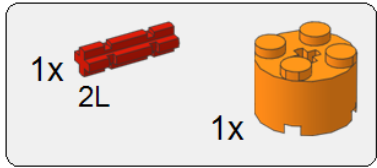

3

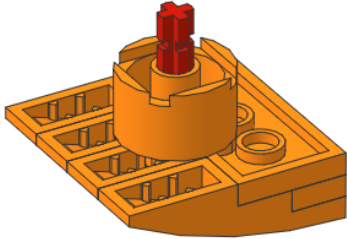

x2

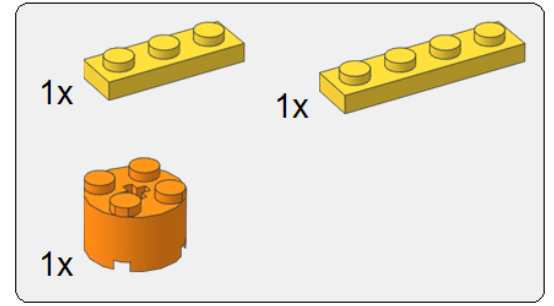
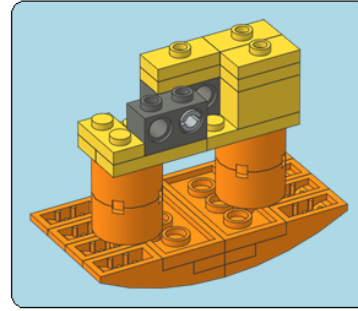

1

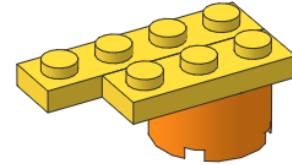

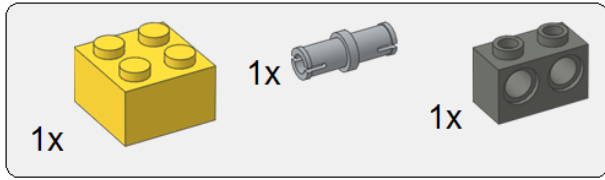

**2**

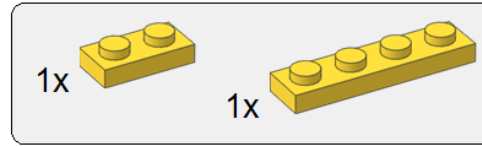
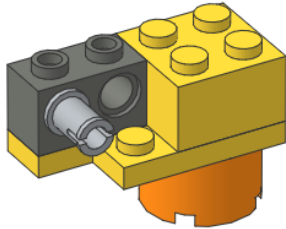

**3**

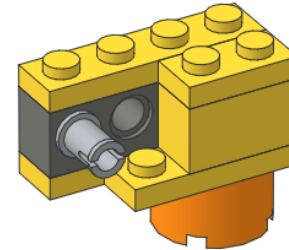

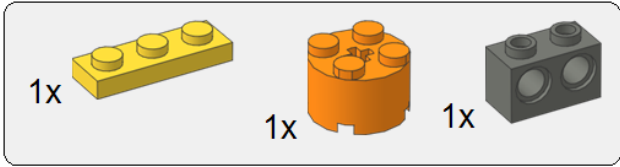

**4**

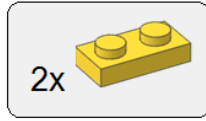
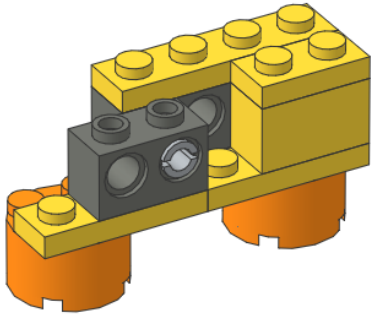

**5**

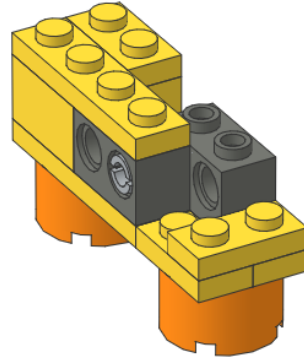

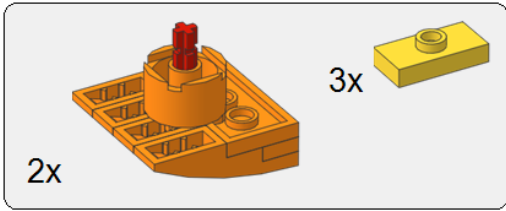

6

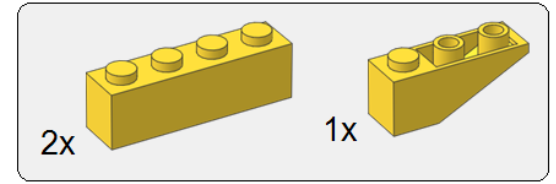
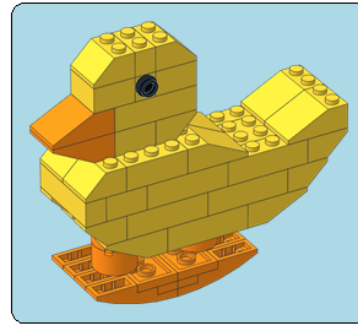
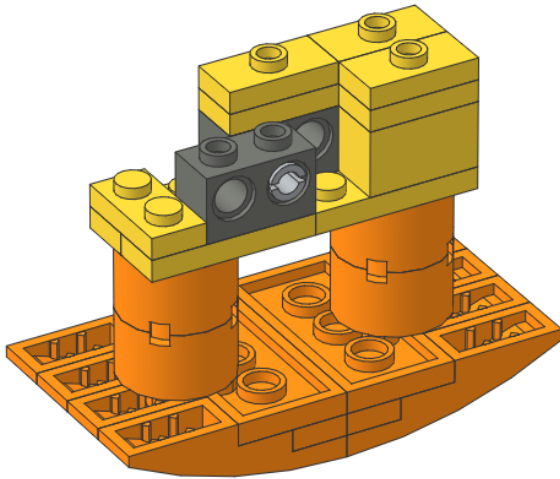

1

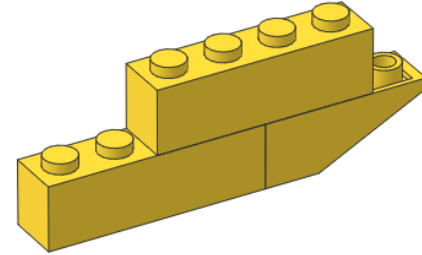

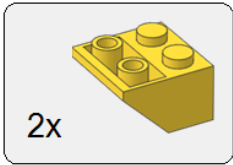

**2**

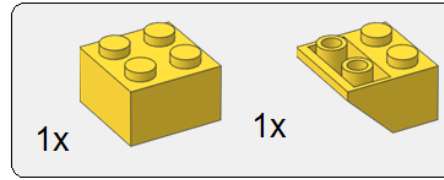
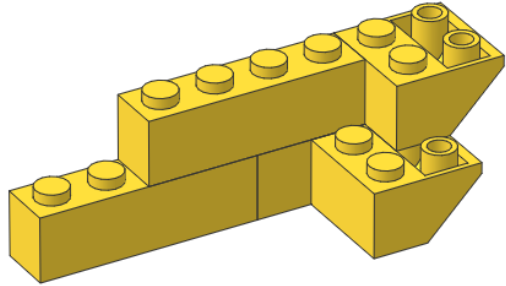

**3**

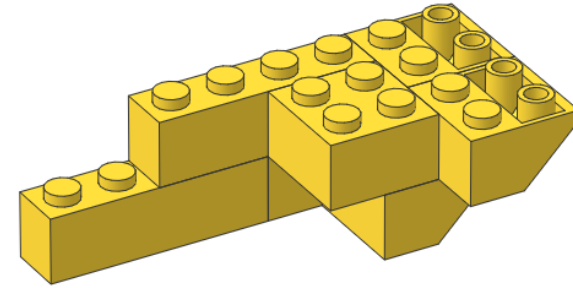

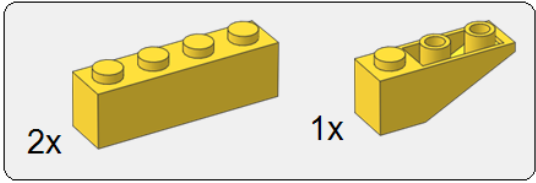

**4**

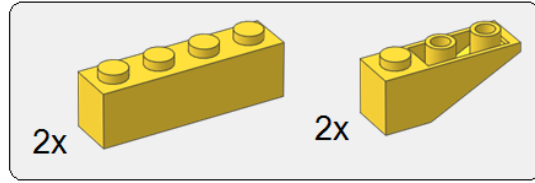
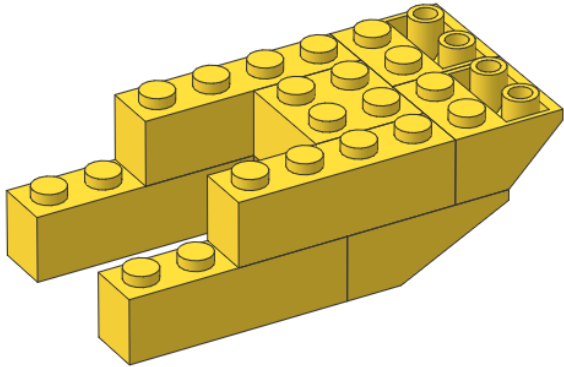

**5**

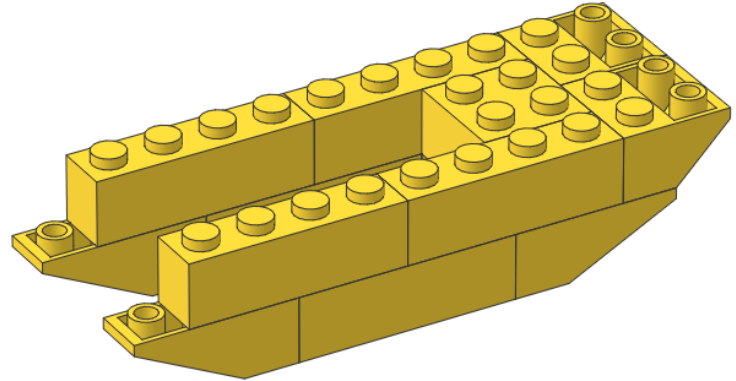



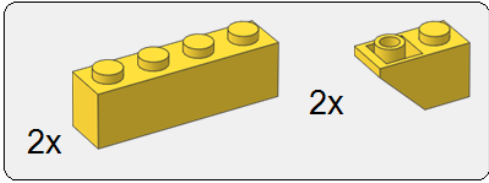

6

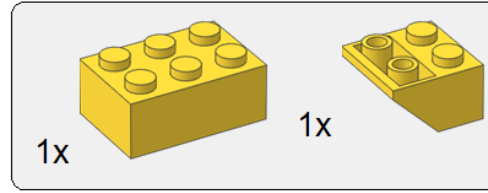
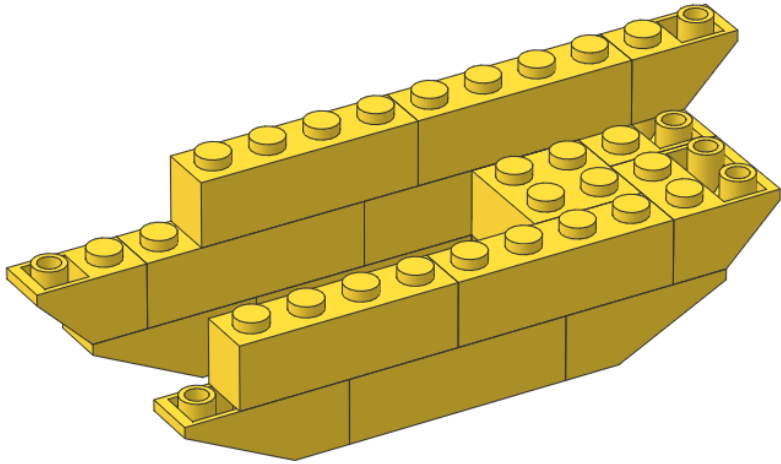

7

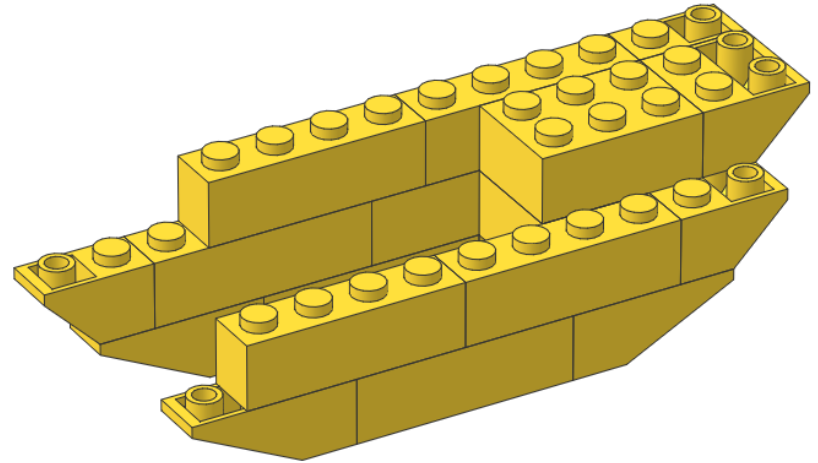

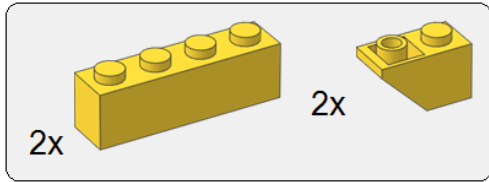

8

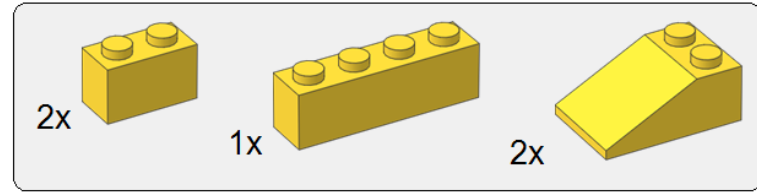
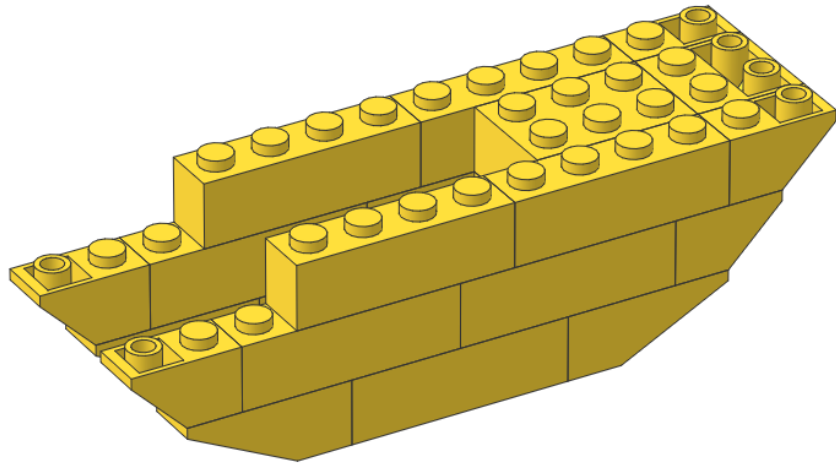

9

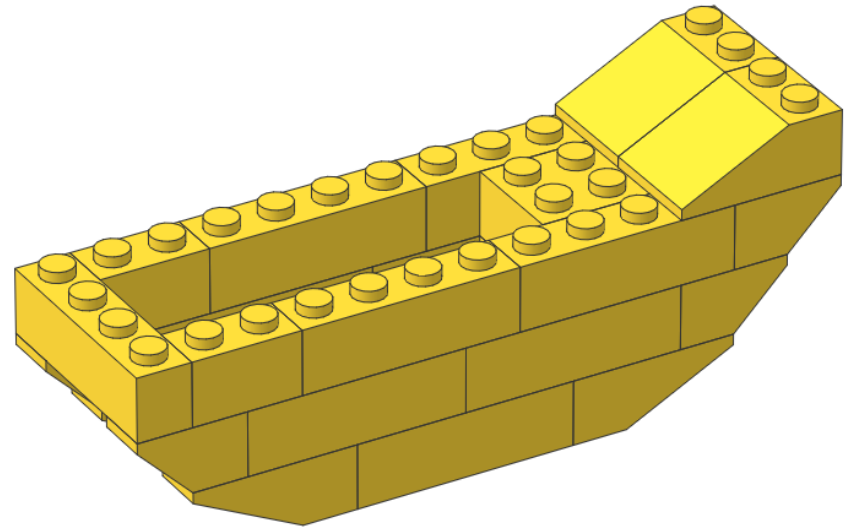

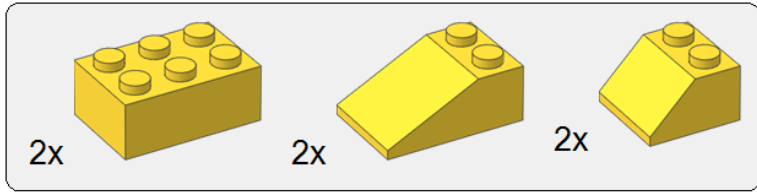

10

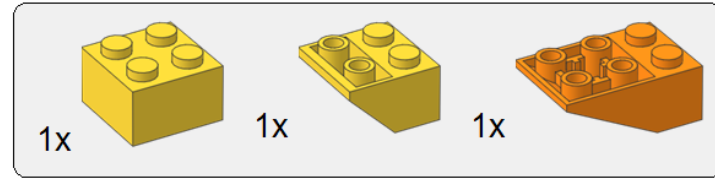
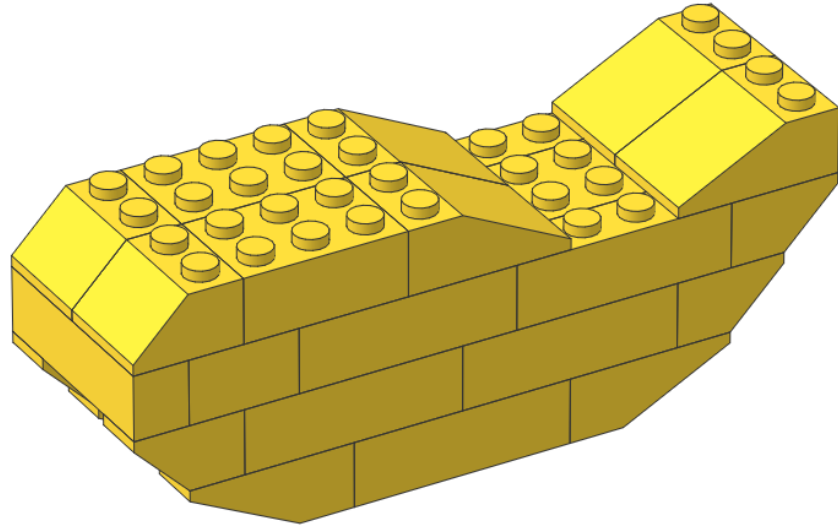

11

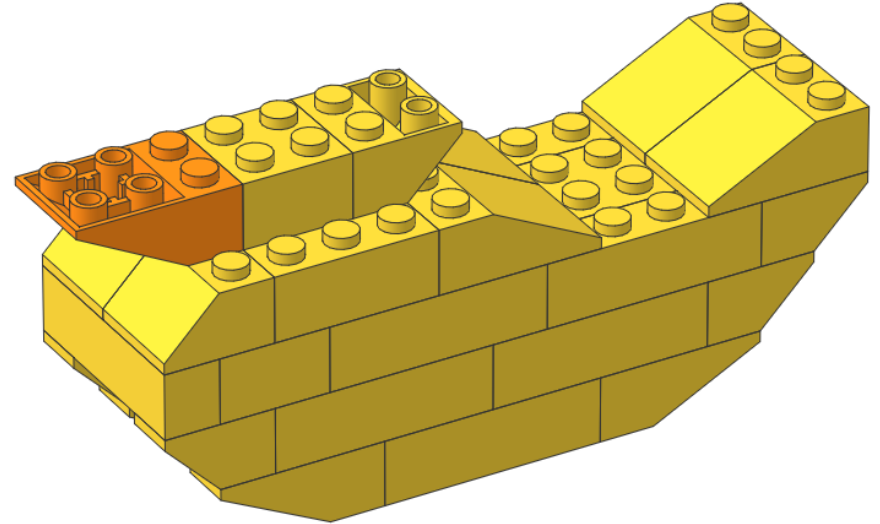

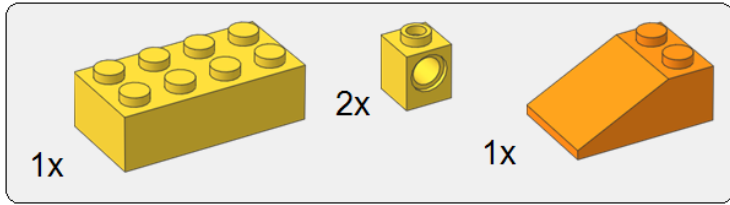

12

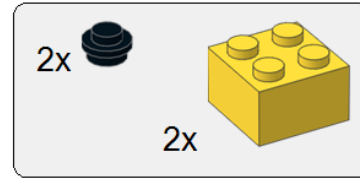
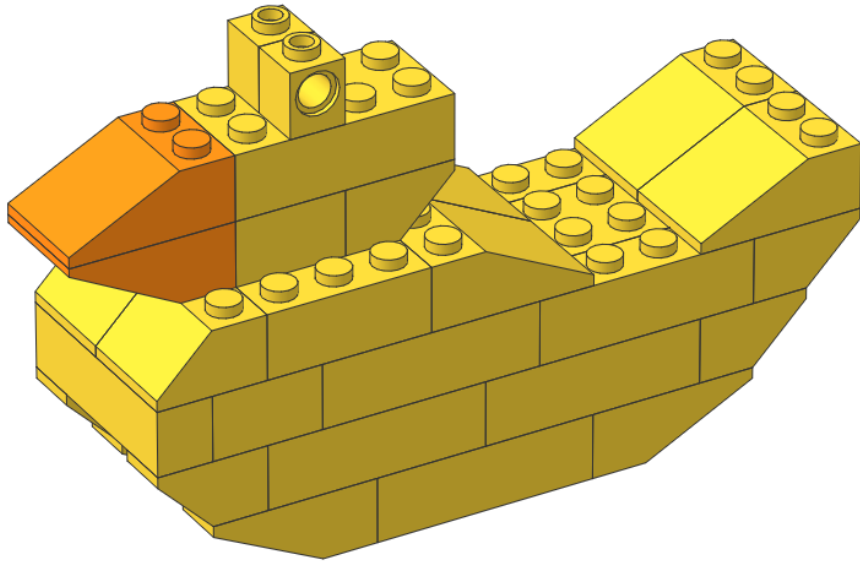

13

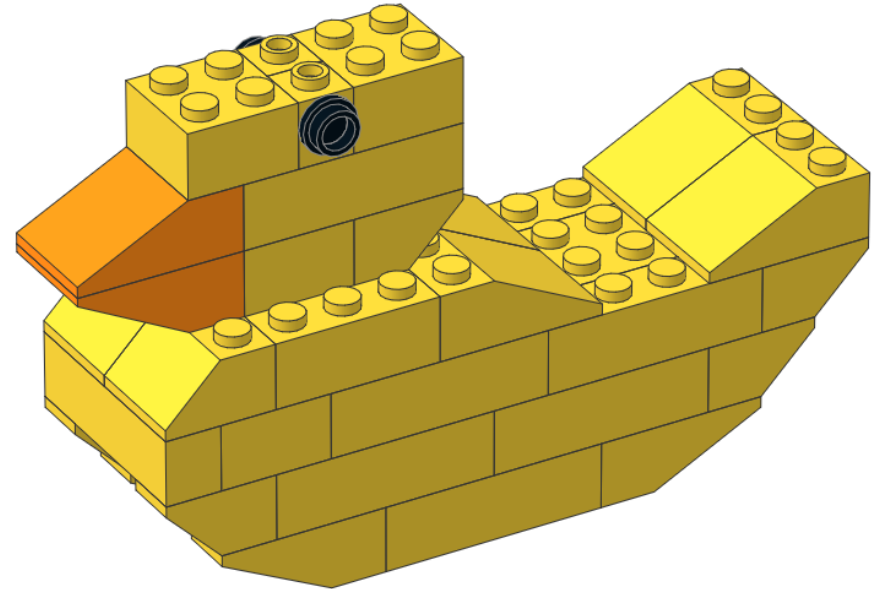

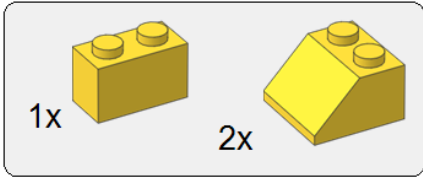

14

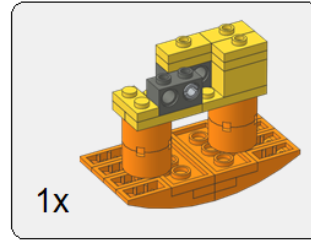
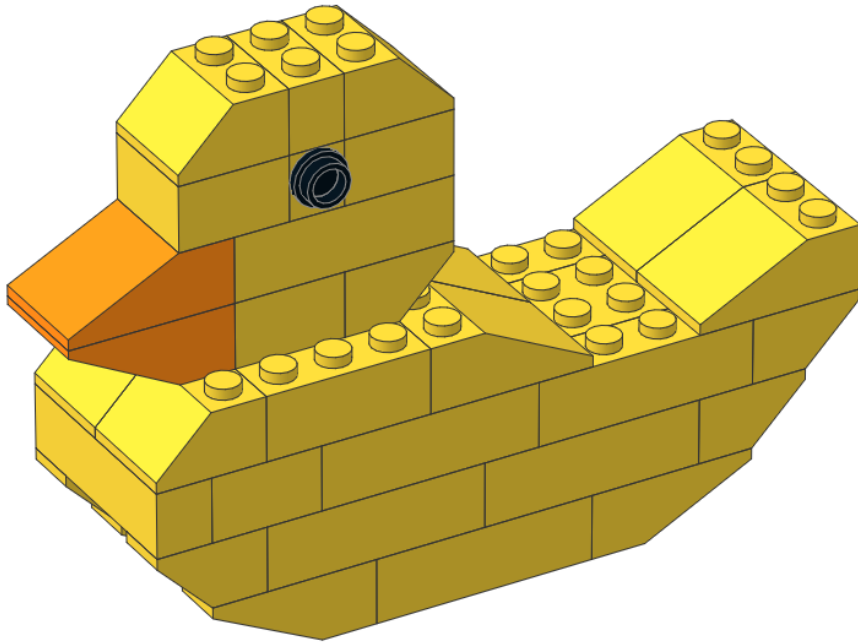

15

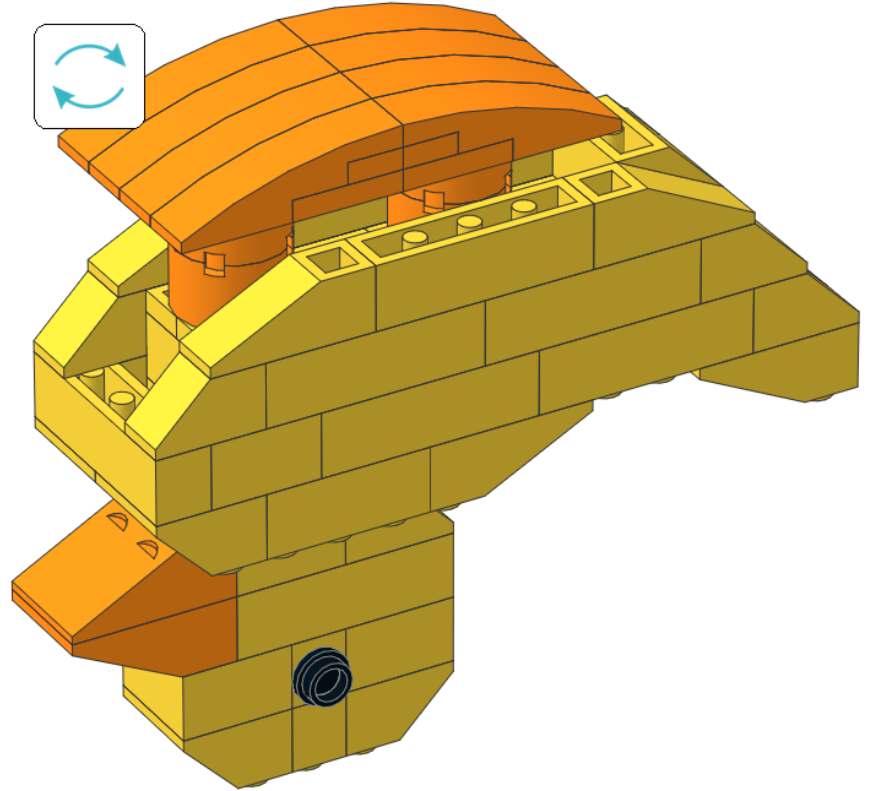

2x



2x



2L

3x



11x

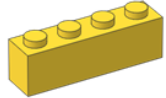

5x



3x

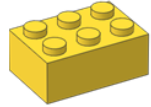

1x

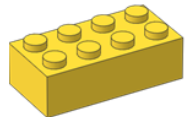

3x



3x



2x



2x

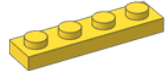

4x

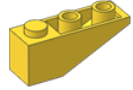

4x

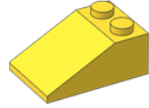

4x



4x



5x

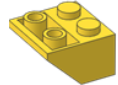

2x



4x



2x

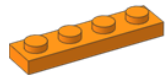

2x

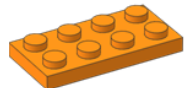

1x

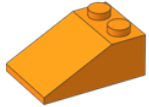

1x

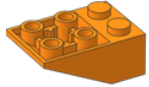

8x



1x



2x



1505 Waddling Duck

A custom model design by Jason Allemann

Copyright © 2015

To see more of my models, visit [jkbrickworks.com](http://jkbrickworks.com)

Instructions automatically published using Instructor version 1.6

These instructions and the model they depict are in no way sponsored, endorsed, or authorized by The LEGO Group.